



Horizontal Tenon Adaptors

Catalog Number	
Project	Type

FEATURES & SPECIFICATIONS

APPLICATION — The TH series of tenon adaptors were designed to adapt an existing vertical 2-3/8" OD tenon to provide one or more horizontal 2-3/8" OD tenon to allow mounting of a fixture via an adjustable slip fitter (2AF).

CONSTRUCTION — The standard heavy duty tenon is constructed of aluminum tubing with 4" arm. Stainless steel hardware and top cap provided. Available in custom lengths. All custom lengths longer than 4" is constructed of steel tubing. Stainless steel hardware and top cap provided.

FINISH — A Super Durable Polyester powder coat finish is electrostatically applied in our state of the art paint facility. Standard colors available: Black, Bronze, US Green, White. Custom colors available upon request.

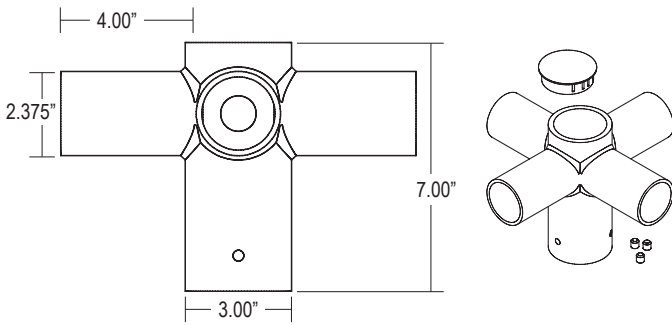

TH490 shown. All tenon configurations conform to the same tubing and tenon dimensions.



TH190



TH290



TH390



TH2180



TH3120



TH490

ORDERING INFORMATION

Choose the bold face options for the appropriate luminaire configuration for your application and enter on the line above each fixture attribute. Accessories may be factory installed, depending on the particular accessory chosen, but still be ordered as a separate line item.

EXAMPLE:

TH190BZ

TH	TENON CONFIGURATION	ARM LENGTH ¹	MATERIALS	FINISH
190	= 1 Tenon	Blank = 4" Arm ¹	Blank = Aluminum ¹	BZ = Bronze
290	= 2 Tenons at 90°	6 = 6" Arm	S = Steel ²	BK = Black
2180	= 2 Tenons at 180°	8 = 8" Arm	GALV = Galvanized	GR = US Green
390	= 3 Tenons at 90°	10 = 10" Arm		WH = White
3120	= 3 Tenons at 120°	12 = 12" Arm		SP = Special ²
490	= 4 Tenons at 90°	16 = 16" Arm		

NOTES

1 = Standard arm is 4" made of aluminum.

2 = Any lengths over 4" is made of steel.

CUSTOM TENON ADAPTOR DEMONSTRATION

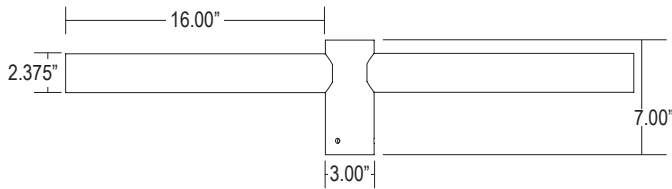

TH2180-16 shown. All tenon configurations conform to the same tubing and tenon dimensions.

TH190-16

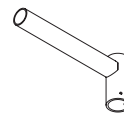

TH290-16

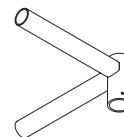

TH2180-16

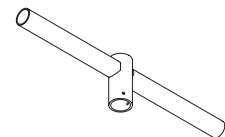

TH390-16

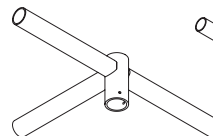

TH3120-16

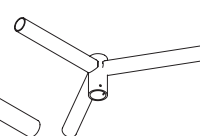

TH490-16

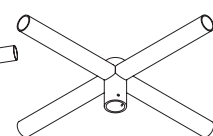

CUSTOM TENON ADAPTOR DEMONSTRATION

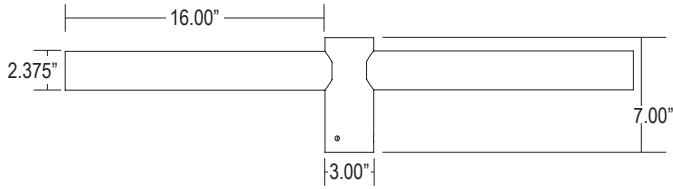

TH2180-16 shown. All tenon configurations conform to the same tubing and tenon dimensions.

TH190-16

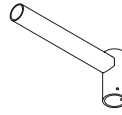

TH290-16

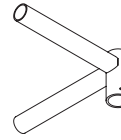

TH2180-16

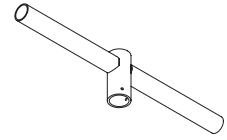

TH390-16

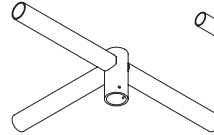

TH3120-16

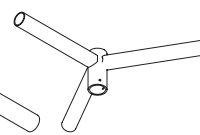

TH490-16

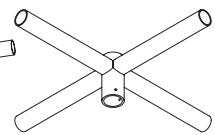

EPA RATING [ft²]

TH Arm EPA						
Arm Length	4"	6"	8"	10"	12"	16"
TH190	0.11	0.12	0.14	0.16	0.17	0.2
TH290	0.12	0.15	0.17	0.2	0.22	0.27
TH390	0.16	0.2	0.24	0.28	0.32	0.4
TH2180	0.14	0.17	0.2	0.24	0.27	0.34
TH3120	0.16	0.2	0.24	0.28	0.32	0.4
TH490	0.17	0.22	0.27	0.32	0.37	0.47

