



Catalog Number	
Project	Type

**FEATURES & SPECIFICATIONS**

**APPLICATION** – The high performance luminaire is designed for area lighting applications where long life, low maintenance, and consistent color rendering is required. Areas with limited accessibility due to fixture location or where heavy pedestrian or vehicle traffic makes maintenance difficult are ideal applications such as parking lots or walkways. It is also compact and versatile enough for general purpose security lighting.

**CONSTRUCTION** – The heavy duty housing is constructed of extruded aluminum. The optical assemblies are sealed in place using a silicone gasket for weather tight protection. Modular LED bricks wired in parallel for ease of maintenance. ETL listed for wet locations (IP64). Additional IP66 rating available upon request.

**FINISH** – A Super Durable Polyester powder coat finish is electrostatically applied in our state of the art paint facility. Standard colors available: Black, Bronze, US Green, White. Custom colors available upon request.

**OPTICAL SYSTEM** – Made with a state of the art UV stabilized acrylic high performance refractive optical assemblies that use high transmissivity materials to achieve precise photometric distributions. Available in Type II, III, IV, IV Automotive, Automotive Frontline Wide, IV Tennis, V Narrow, V Medium and V Wide beam configurations. Optics may be ordered rotated 90 degrees for perimeter lighting or walkway applications (optics are not field rotatable). The full cutoff fixture is Star Light Friendly (meets or exceeds Dark Sky requirements) in the horizontal position.

**ELECTRICAL SYSTEM** – Available in up to a 8 brick LED system in 5000K-70 CRI Cool White (+/- 500K) or 4100K-70 CRI Neutral White color temperatures propagated with CREE® XLamp XHP70 LED's. Consult factory for high CRI (90+) model availability. Available with 100-300V 50/60 Hz Class II power supply. LED's rated for over 50,000 hours at 25°C ambient temperature. 347V~480V input option available. 0-10V dimming. Built-in surge protection up to 10 kV. Built-in Active PFC Function >95%/Full load. LED Power Supply conforms to UL8750 standards and is IP65 rated for wet locations.

**MOUNTING** – The fixture is designed to mount directly to a square pole. An adaptor is available for direct mount to round poles. Techlight's Quick Mount Bracket for flush mount or the Quick Mount Bracket with various arm lengths also available. All mounting options allow the Tapered Back Dagger to mount at 90 degree intervals.

**LISTINGS** – LED Power Supply listed for wet locations (IP67). LED bricks ETL listed for wet locations (IP64). Meets US and Canadian safety standards. -40°C to 50°C ambient operation. RoHS Compliant.

**WARRANTY** – The complete luminaire is covered by a 5-year limited warranty.

**Tapered Back  
Dagger LED Area Light  
LDG SERIES**

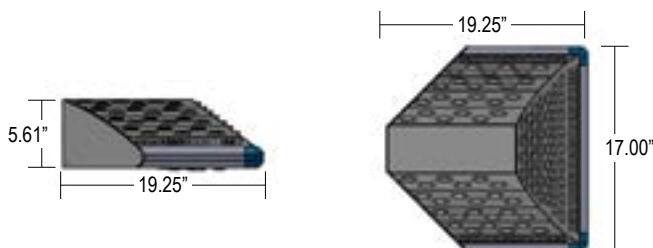
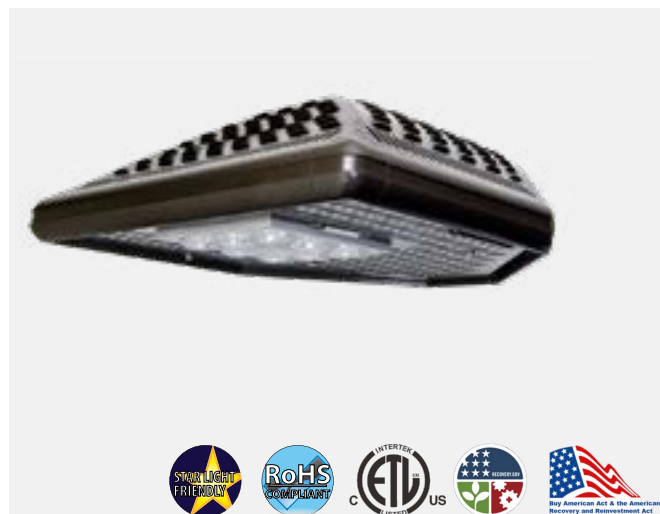

Dimensions shown are for 1 Brick Unit Only. Mounting options must be ordered separately.

Series	Housing Height	Length & Width
<b>LDG</b>	5.61"	19.25" x 17.00"

**ORDERING INFORMATION**

Choose the bold face options for the appropriate luminaire configuration for your application and enter on the line above each fixture attribute. Accessories may be factory installed, depending on the particular accessory chosen, but still be ordered as a separate line item.

Example: **LDG 1 C X T3 F 1 BZ QMB**

**(NOTE: QMB Must Be Ordered Separately)**

Series	# of Bricks	Color Temp	# LED's per Brick	Optics	Drive Current	Voltage	Finish	Options
<b>LDG</b>	<b>1</b> 1 Brick <b>2</b> 2 Brick	<b>C</b> Cool White (5000K) <b>N</b> Neutral White (4100K)	<b>X</b> 8 XHP70 LEDs	<b>T2</b> Type II <b>T3</b> Type III <b>T4</b> Type IV <b>T4A</b> Type IV Automotive <b>FAW</b> Frontline Automotive Wide <b>T4T</b> Type IV Tennis <b>T5N</b> Type V Narrow <b>T5M</b> Type V Medium <b>T5W</b> Type V Wide	<b>F</b> 1400mA Driver	<b>1</b> Multi-Volt <sup>1</sup> <b>2</b> 347~480V	<b>BK</b> Black <b>BZ</b> Bronze <b>GR</b> US Green <b>WH</b> White <b>SP</b> Special <sup>2</sup>	<b>L</b> Left Rotated Optics <b>R</b> Right Rotated Optics (Leave Blank for standard optics)

NOTES

- Multi-Volt is an auto ranging power supply from 90V to 300V input.
- Custom RAL color matching is available. Contact your Techlight sale representative for additional information.
- Additional IP66 rating may not be changed once production has begun on the fixtures.
- Photocell Receptacle must be installed at the factory. No field installation.

**Accessories** (Order as separate line items)

<b>EXB</b>	Extension Arm Mount Bracket	<b>RPASSA</b>	Round Pole Mount Adaptor for Direct Mounting
<b>WMUPS42</b>	42" Extension Arm with Wall Mount	<b>IP66<sup>3</sup></b>	Additional IP66 Fixture Rating
<b>QMB</b>	Quick Mount Bracket - Flush, No Arm	<b>PCR7<sup>4</sup></b>	7-Pin Twist-Lock Photocell Receptacle ANSI C136.41 and Receptacle Shorting Cap
<b>QMSSA-S</b>	Quick Mount Bracket with 2" Straight Arm	<b>PC2</b>	480V Twist-Lock Photocell
<b>QMSSA-M</b>	Quick Mount Bracket with 8" Straight Arm	<b>PC6</b>	Multi-Tap (105-285V) Twist-Lock Photocell
<b>QMSSA</b>	Quick Mount Bracket with 10.75" Straight Arm		

# LDG Tapered Back Dagger LED Area Light

## LUMINAIRE CHARACTERISTICS

### 1400 mA Drive Current

# of LED Bricks	Drive Current	Color Temp	Delivered Lumens									System Wattage	L70 @ 25°C	Amperage Draw			
			TYPE II	TYPE III	TYPE IV	TYPE 4A	TYPE 4T	FAW	TYPE 5N	TYPE 5M	TYPE 5W			120V	208V	240V	277V
1 BRICK	1400 mA	Cool White (5000K)	14893	14658	16407	16062	15418	15477	17137	17313	15542	147	>50K	1.23 A	0.71 A	0.62 A	0.54 A
2 BRICK	1400 mA	Cool White (5000K)	25613	25212	28220	27687	26519	26621	29476	29465	26732	251	>50K	2.45 A	1.42 A	1.23 A	1.07 A
1 BRICK	1400 mA	Neutral White (4100K)	14320	14094	15776	15444	14825	14882	16478	16647	14944	147	>50K	1.23 A	0.71 A	0.62 A	0.54 A
2 BRICK	1400 mA	Neutral White (4100K)	24630	24242	27135	26564	25499	25597	28342	28633	25617	251	>50K	2.45 A	1.42 A	1.23 A	1.07 A

## MOUNTING ACCESSORIES

### QMB

Quick Mount Bracket - Flush, No Arm

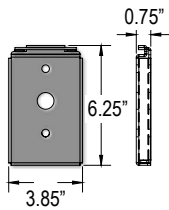

Quick Mount Bracket with no arms mounted 4 fixtures, at 90 degrees on a square pole.

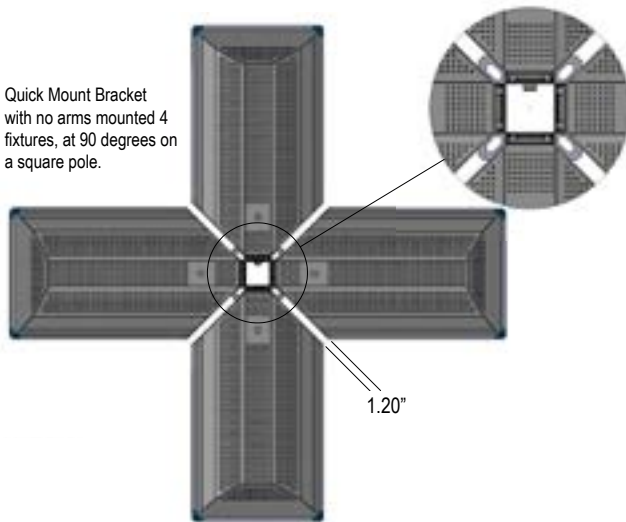

### QMSSA-S

Quick Mount Bracket with 2" Straight Arm

### QMSSA-M

Quick Mount Bracket with 8" Straight Arm

### QMSSA

Quick Mount Bracket with 10.75" Straight Arm



### RPASSA

Round Pole Mount Adaptor for Direct Mounting

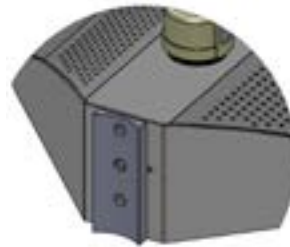

### WMUPS42

42" Extension Arm with Wall Mount

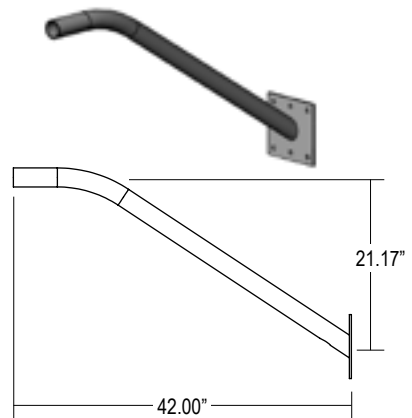

Dimensions shown are for the 2 brick model. Mounting options must be ordered separately.

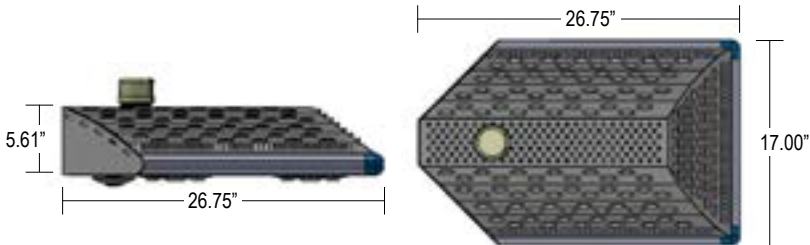

Techlight, Inc.  
 2707 Satsuma Drive  
 Dallas, TX, 75229  
 Phone: 214-350-0591, 800-225-0727, Fax: 214-350-9137  
 www.techlight.com